



آي بيست م م ح  
I Best FZE

# حلول توفير المساحة SPACE SAVER SOLUTIONS

WholeSale Trade تجارة البيع بالجملة  
(General Trading) (التجارة العامة)

+971 54 2696590

+971 50 7151677

sales@ibestfze.com

www.ibestfze.com

Ind. Area Al Sajja Sharjah  
Near Tahseel Roundabod



Scan for location

## Industrial Shelves



### Shelves With 600mm

Size (mm)	Levels	Loading Capacity Kg
2000 (H) X 2000 (L)	4 layers	200/300/400/500/ 1 TON
2000 (H) X 1500 (L)	4 layers	200/300/400/500/ 1 TON
2000 (H) X 1000 (L)	4 layers	200/300/400/500/ 1 TON
2500 (H) X 2000 (L)	4 layers	200/300/400/500/ 1 TON
2500 (H) X 1500 (L)	4 layers	200/300/400/500/ 1 TON
2500 (H) X 1000 (L)	4 layers	200/300/400/500/ 1 TON



## Supermarket Display Racks



### Super Market Shelf Double Side

Size (mm)	
	L120x W35x H200cm
	L100x W35x H200cm
	L90x W35x H200cm
	L100x W40x H200cm



## Boltless Shelves



### 5 Tier 200kg Per Layer Capacity

Size (mm)	
	1200 (L) X 450 (D) X 2000 (H)
	1500 (L) X 450 (D) X 2000 (H)
	900 (L) X 450 (D) X 2000 (H)



## Rivet Shelves



### 70-80kg Loading Capacity 2000mm Height

MDF LEVELS	1200 (L) X 400 (D)
	900 (L) X 400 (D)
	1200 (L) X 600 (D)
STEEL LEVELS	1200 (L) X 400 (D)
	900 (L) X 400 (D)
	1200 (L) X 500 (D)



## Steel Multifunctional Scaffolding

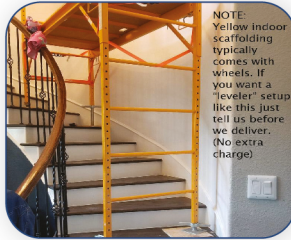

## Aluminium Multifunctional Scaffolding



## Concertina Loft Ladder



### CEILING LADDER



### BEAM LADDER

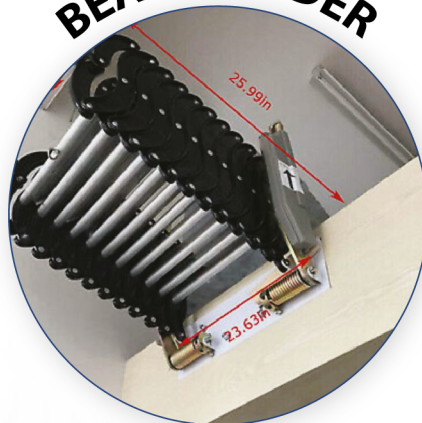

### WALL LADDER



## Exhibition Truss Series

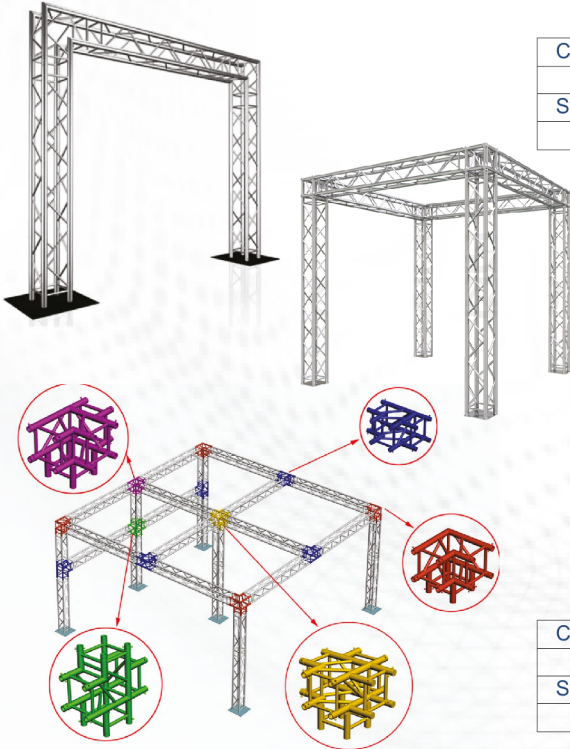
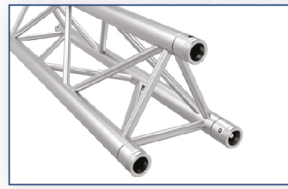

	1m	2m	3m	4m	5m	6m	7m	8m	9m	10m	11m	12m	13m	14m	15m	16m
Center Point load (kg)	1719.8	913.9	606	451.3	357.6	294.5	248.8	214.2	186.7	164.5	146	130.2	116.5	104.5	93.9	84.3
Deflection (mm)	1	4	8	14	22	32	43	57	72	89	107	127	150	174	199	227
Symmetrical load (kg)	1720	1516.8	1006	748.8	593.2	488.8	412.8	355.5	310	273.2	242.4	216	193	173.5	155	140
Deflection (mm)	1	2	6	11	18	26	35	45	57	71	86	102	120	139	159	181

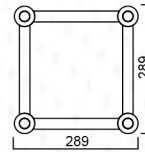
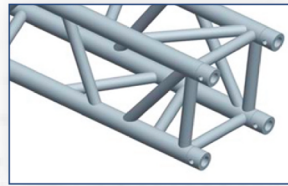
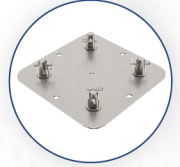
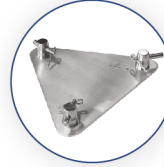
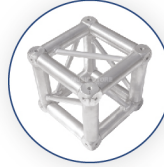
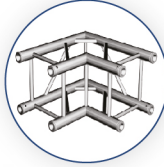

**CS 30 Square Truss**  
 size: 289x289mm  
 main tube: Ø50x3mm  
 brace: Ø20x2mm  
 length: 0.5m-4m

	1m	2m	3m	4m	5m	6m	7m	8m	9m	10m	11m	12m	13m	14m	15m	16m
Center Point load (kg)	1985.5	1980.2	1405	1049.4	834.8	691.1	587.5	509.4	448	398.3	357.3	322.5	292.8	267	244	224
Deflection (mm)	1	4	9	17	26	37	51	66	84	103	125	149	175	202	233	264
Symmetrical load (kg)	1985.5	1980.2	1974.8	1742	1386	1146	972	844	743.6	661.2	593.2	535.6	486	443.2	405.3	372
Deflection (mm)	1	3	7	13	21	30	41	53	67	83	100	119	140	162	186	212

## Mobile Manual Lift

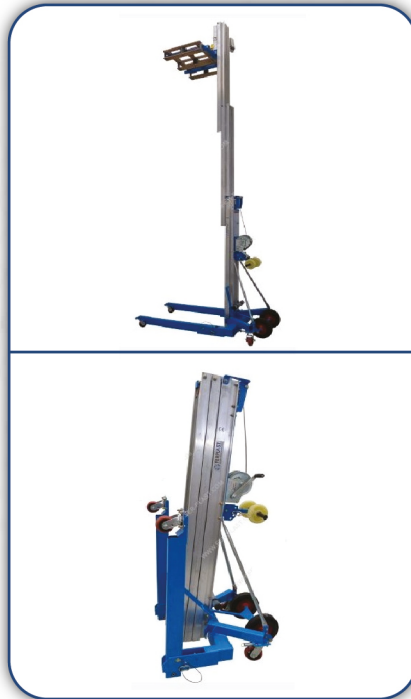

Modle	Max Raised H (m)	Maximu Load (kg)	Machine Weight (kg)	Dynamic Forms
LGA- 10	3.5	320	145	manually operation
LGA- 15	5.0	300	170	
LGA- 20	6.5	250	190	
LGA- 25	7.9	200	210	

**Multipurpose  
Aluminium Ladder**



**Warehouse Mobile Aluminium Ladder**



**Aluminium Ladder**

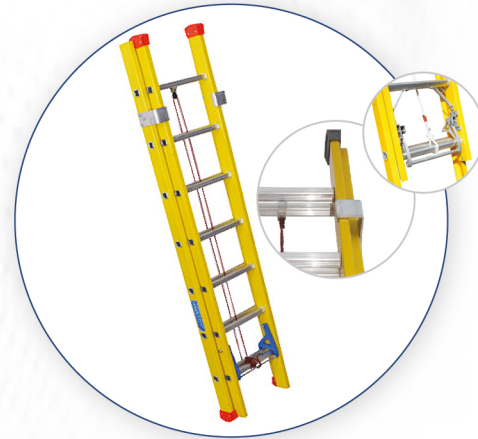

**Fiber Glass Double  
Extension Straight Ladder**



**Single Telescopic Ladder**



**A Type Telescopic Ladder**



**Extension Ladder**



**Heavy Duty Step Aluminium Ladder**



**Customized Product**



**Customized Product**

## Wheels Trolley Platform Trolley



### Safe Working Load 200 Kgs

Code	Base Width	Base Depth	Tower Height
2000 (H) X 2000 (L)	2000 (H) X 2000 (L)	2000 (H) X 2000 (L)	2000 (H) X 2000 (L)
2000 (H) X 1500 (L)	2000 (H) X 1500 (L)	2000 (H) X 1500 (L)	2000 (H) X 1500 (L)
2000 (H) X 1000 (L)	2000 (H) X 1000 (L)	2000 (H) X 1000 (L)	2000 (H) X 1000 (L)



## Mobile Scissor Lift



Model	Capacity Kg	Raised H(mm)	Low H(mm)	Platform Size(mm)	Elevating Time (S)	Lifting Motor (KW)	Electric Source (AC/DC)	Machine Weight (Kg)
SJYO.2-4	200	4000	850	1500*700	23	0.75	AC220V/DC24V 50 HZ	500
SJYO.48-6	480	6000	950	1780*840	49	1.5		750
SJYO.48-9	480	9000	1550	2000*1000	81	1.5		1300
SJYO.48-11	480	11000	1600	2100*1200	80	2.2		1380
SJYO.48-12	480	12000	1750	2450*1350	90	3		1850
SJYO.48-14	480	14000	1800	2600*1500	132	4		2500
SJYO.3-16	300	16000	1980	2000*1000	100	4		2680
SJY1-6	1000	6000	1330	2100*1200	48	2.2		1380
SJY1-9	1000	9000	1600	2400*1500	55	4		1850
SJY 1-12	1000	12000	1800		86	4		3000

## Stanchions Poles & Ropes

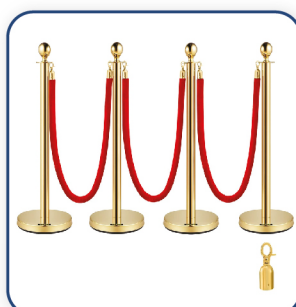

## Wheels Trolley Platform Trolley



**PLATFORM TROLLEY - 150 KG**

740 x 480 x 134 (LWH)  
(Floor Height) MM



**PLATFORM TROLLEY - 300 KG**

910 x 610 x 210 (LWH)  
(Floor Height) MM



**PLATFORM TROLLEY - 500 KG**

1240 x 790 x 200 (LWH)  
(Floor Height) MM

## Caster Wheels



## Accessories



### GI PANEL

300 x 900 mm

300 x 1000 mm

300 x 1100 mm

300 x 1200 mm



### FRAME 600 mm

900 to 1200mm



### BEAM SIZES

2700 x 100 x 50mm

3000 x 100 x 50mm

3300 x 100 x 50mm

2700 x 120 x 50mm

3000 x 120 x 50mm

3300 x 120 x 50mm

2700 x 140 x 50mm

3000 x 140 x 50mm

3300 x 140 x 50mm



### MESH WIRE PANEL

111 x 110cm

81 x 150cm

106 x 135cm

101 x 135cm

81 x 135cm

905 x 120cm

905 x 90cm

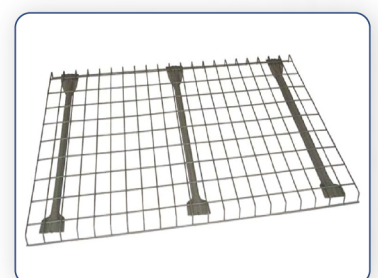



## MEZZANINE FLOOR & BARRIERS



Clamp Style Hand Rail



Heavy Duty Mezzanine



Mezzanine Floor Gallery



Heavy Duty Rack



IN Rack Mezzanine



GI GRATING SERVICES